

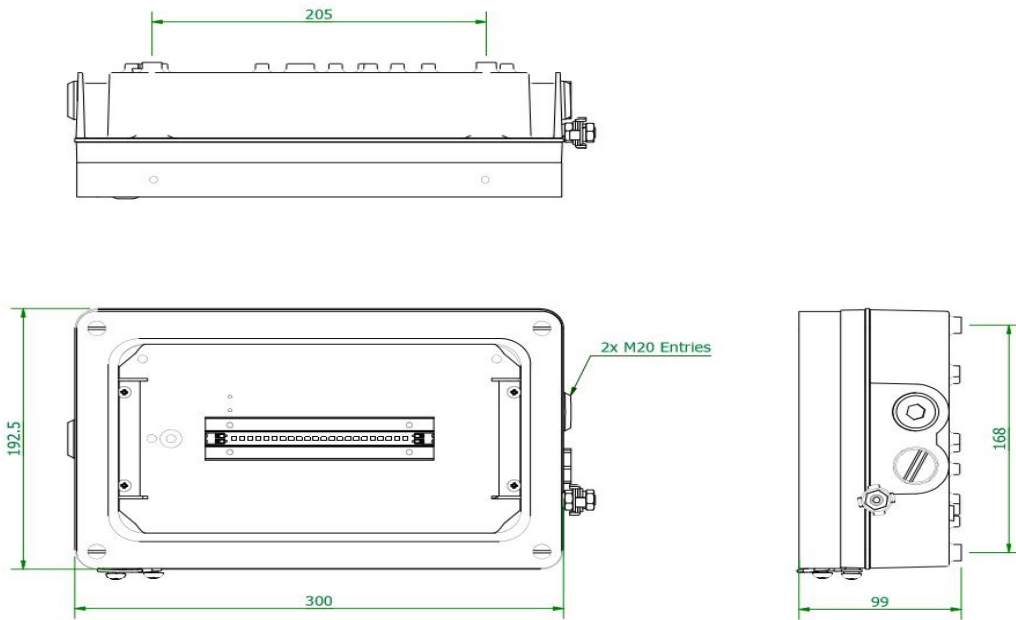

INSTALLATION, OPERATION AND MAINTENANCE INSTRUCTIONS

NEXLED 3 Standard & Emergency

Industrial

Important: Please read these instructions carefully before installing or maintaining this equipment. Good electrical practices should always be followed, this data should be used as a guide only.



0.0 Specification	
Type of Protection	N/A
Standards	EN 60598-1, EN 60598-2-22
Area Classification	Industrial (Non- Hazardous)
Ambient	Non-Emergency (-40°C to +50°C), Emergency (-20°C to +50°C)
Ingress Protection	IP66/67 to EN 60529
 	<p>The CE marking of this product applies to "The Electrical Equipment (Safety) Regulations 2006", "The Electromagnetic Compatibility Regulations 2004", the "Waste Electrical and Electronic Equipment Regulations 2006". [This legislation is the equivalent in UK law of EU directives 2014/35/EU, 2014/30/EU, 2012/19/EU respectively].</p> <p>The UKCA marking of this product applies to "The Electrical Equipment (Safety) Regulations 2016", "The Electromagnetic Compatibility Regulations 2016", the "Waste Electrical and Electronic Equipment Regulations 2012</p> <p>M Poutney Technical Manager</p>

Luminaire is supplied with battery plug/Socket disconnected, just prior to switching power on, connect battery plug and socket.

1.0 Introduction

The Chalmit NexLED non-emergency & emergency brings the very latest in lighting technology. It is a compact light source that uses ultra bright light emitting diodes in 4K or 5K options to provide light from mains power and for emergency from internal battery back up on mains failure. The electronics are housed in an impact and corrosion resistant marine grade aluminium enclosure with a toughened glass lens. The control gear is electronic with regulated lamp output. The LEDs work equally well at low temperatures as they do at high, giving a product with very low overall power consumption.

The product is available with 1,2 or 3 LED modules and as an exit sign version with which a self-adhesive label kit is used.

Wiring Diagrams

Typical NL3I/01L/LE

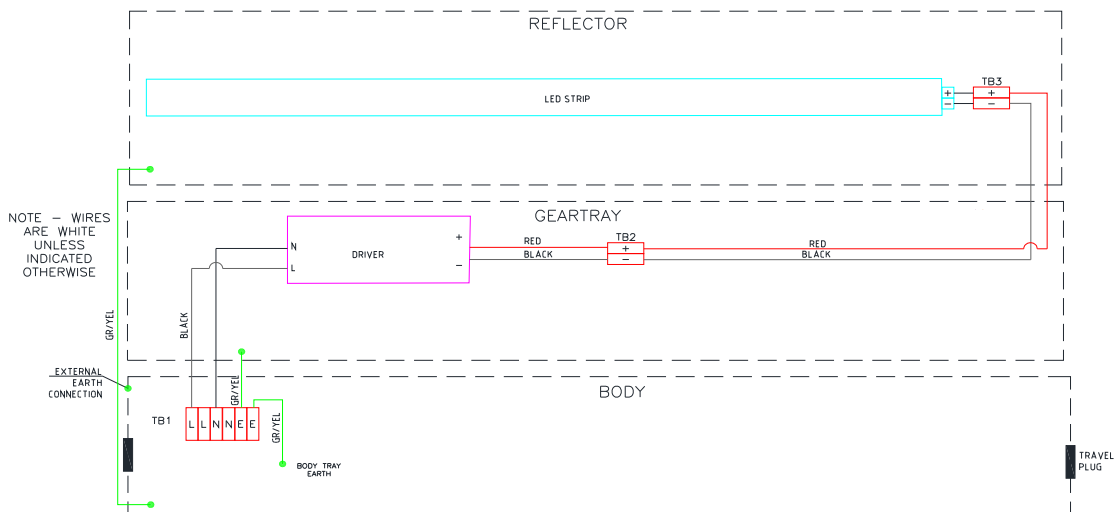

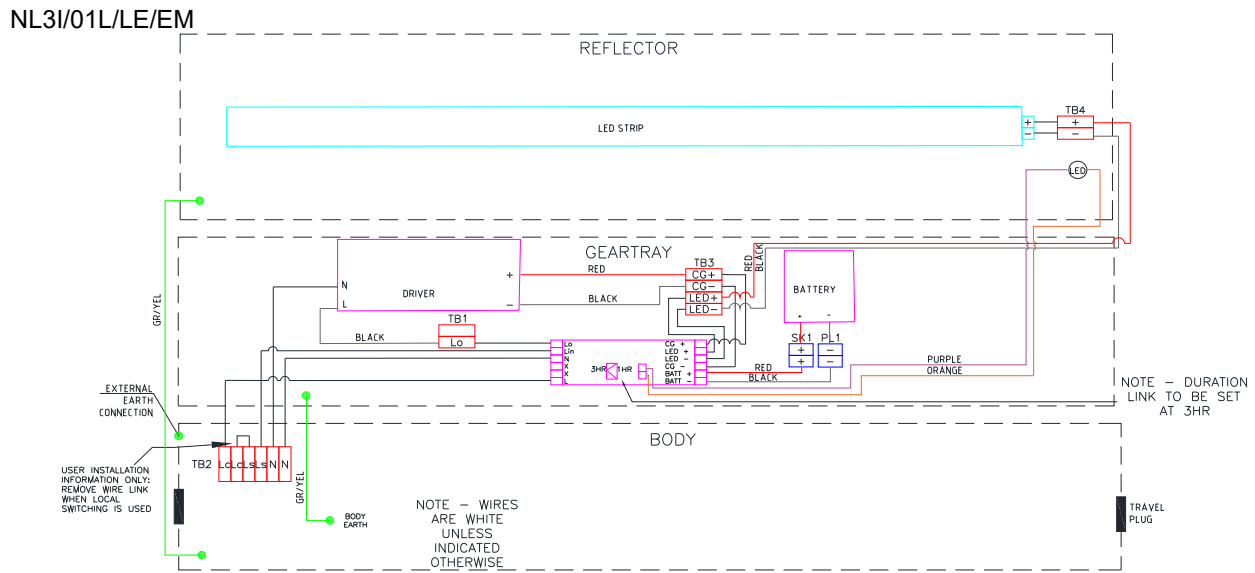

2.0 Storage

Luminaires are to be stored in cool dry conditions preventing ingress of moisture and condensation. Battery packs in storage should be cycled charged/discharged/charged every 9 months, as per instructions below. **Always fully disconnect battery plug from socket for storage.** Any specific instructions concerning emergency luminaires must be complied with. (Warning: Battery packs not cycled and stored for a year may not be recoverable)

3.0 Installation and Safety

3.1 General

These instructions should be read fully and carefully before attempting to install the luminaire. For details of servicing operations, opening etc. see section 6.0.

Copies of these instructions should be held in a safe place for future reference. It is the responsibility of the installer to ensure that the apparatus selected is fit for its intended purpose and that the installation, operation and maintenance of the apparatus complies with applicable regulations, standards or codes of practice. Installation should be carried out in accordance with *the IEE wiring regulations and any local authorised practices.*

Any specific installation instructions must be referred to. In the UK the requirements of the *Health and Safety at Work Act* must be met, and electrical work associated with this product must be in accordance with the *"Manual Handling Operations Regulations"* and *"Electricity at Works Regulations 1989"*. Disposal instructions should be complied with.

The luminaires should be considered Class 1 to EN 60598 and effectively earthed.

DO NOT MEGGER

3.2 Tools

3mm and 5mm flat blade screwdriver
Spanners for installing cable glands.
Pliers, knife, wire Strippers/cutters.
Replacement: T20 Screwdriver

3.3 Electrical Supplies

The standard unit is rated for a nominal 120-277V AC 50/60Hz and the Emergency version is rated for a nominal 220-240V AC 50/60 Hz. A maximum voltage variation of +/-6% on the nominal is acceptable; however, the driver and Emergency Inverter are designed to accept tolerances of up to +/-10%. Luminaires should not be operated continuously at more than +/-6% of the rated supply voltage of the control gear.

3.4 LED Module

LED's are supplied in 1187, 2245 or 3872 Lumen options with the colour temperature of 4K or 5K. The LEDs are maintenance free and at 25°C can last up to a calculated 133,000 hrs at L70. Therefore, in many applications replacement of the LED module will be unnecessary. If replacement is required ensure mains supplies are isolated before commencing work. Remove the front cover and then remove the LED array and mounting plate assembly by disconnecting the cables. Assembly is the reverse of disassembly making sure that the earth is connected and ensuring the gasket/glass mating surfaces are clean and cables are not trapped.

3.5 Control Gear

System life >100,000hrs

Therefore, replacement of this component should be unnecessary. If replacement is required ensure mains supplies are isolated before commencing work. Remove the front cover then drop down the LED array. The LED array should be dis-connected first by removing wires from the terminal block, then using an 8mm nut driver the hanging straps should be removed. The geartray can now be taken out with the removal of the 2 Torx head screws. Assembly is the reverse of disassembly, making sure that the earth is connected and ensuring the gasket/glass mating surfaces are clean and cables are not trapped.

3.5 Mounting

Luminaires should be installed where access for maintenance is practical and in accordance with any lighting design information provided for the installation. Mounting is by 4 holes in the base of the body casting external to the gasket. These should be secured with lock washers or self-locking nuts and bolts and are accessed by removing the front cover. Any mounting attitude may be used.

3.6 Cabling and Cable Glands

3.6.1 Cables

The maximum conductor size is 4mm². Internal earth point is provided next to the main terminal block. 300/500V cable ratings are adequate and no special internal construction is necessary. The standard looping cable size is up to 4mm². The selection of cable size must be suitable for the fuse rating. Terminals are supplied with suitability for looping. Where looping is used the maximum current is 16A. Terminals are accessed by removing the front cover and LED array assembly. Maximum cable temperature rise is 20°C above ambient.

3.6.2 Cable glands

The installer and user must take responsibility for the selection of cables, cable glands and seals. Three tapped cable entries are provided. Sealing plugs are provided and a tool must be used for their removal. Cable entries are M20x1.5.

The cable and gland assembly when installed must maintain a minimum of IP66/67 rating.

The cable glands must be suitable for the application. Where brass cable glands are used in a corrosive environment, cadmium or nickel plating should be used.

3.7 Exit Sign Version

To apply the exit label assembly, loosen the M6 wire rope fastener from the front cover, position the assembly and fix in place using the M6 fasteners provided. The illuminated height of the label is 140mm with a maximum visible distance of 28m as defined by EN1838.

3.8 Emergency Operation

When there is a disruption to the mains supply the Nexled will switch over to battery backup instantly.

3.9 Battery Maintenance

The battery pack is a 3.5Ah NiMH cell pack. Periodic testing (minimum period of one year) allowing full discharge will enable the cells to remain in a healthy condition. Should the battery pack need to be replaced spares may be ordered from Chalmit Lighting.

The luminaire must not be operated without the battery connected. If the battery is removed and not replaced the control gear supply must be disconnected at the mains terminal block and secured.

4.0 Inspection and Maintenance

Visual inspection should be carried out at a minimum of 12 monthly intervals and more frequently if conditions are severe.

4.1 Routine Maintenance

Visual tests and checks should be carried out at intervals described by the appropriate regulations and should include the following:

- Check that the LEDs are working.
- Check for mechanical damage/corrosion.
- Check for loose connections including earthing.
- Check for undue accumulations of dust or dirt.
- Verification of tightness of fixing, glands, blanking plugs etc.
- Check for unauthorised modifications.
- Check condition of enclosure gasket and fastenings.
- Check for any accumulation of moisture.
- Periodic inspection of the enclosure seal should be carried out to ensure that the seal is sound.
- If the luminaire has been subjected to abnormal conditions, for example, severe mechanical impact or chemical spillage, it must be de-energised until it has been inspected by an authorised and competent person. If in doubt, the unit should be returned to Chalmit for examination and if deemed necessary replacement.
- Before re-assembling, all connections should be checked, and any damaged cable replaced.

4.2 Routine Testing of Emergency Lighting Functions

Users should ensure that the performance of emergency lighting remains adequate for their purposes by conducting periodic tests and recording the results. Requirements will differ between countries, applications and organisations.

4.2.1 Emergency Lighting Functions

Battery Management Test (BMT) comes as standard on the NexLED III Emergency luminaire range

4.2.2 Commissioning

After installation of the Luminaire and initial connection of the mains supply and battery supply the luminaire will commence charging the batteries for 20 hours (initial charge). Afterwards, the luminaire initiates a commissioning test for the full duration.

Note: If Interrupted this will only delay the process until the battery is fully charged.

The 20 hours recharge occurs also if a new battery is connected or the module exits the rest mode condition. The following automatic commissioning duration test is only performed when a battery is replaced and fully charged (after 20 hrs) and the interval time is not set to zero, otherwise the system is expected to perform the testing.

Note: If the mains supply is to be interrupted for more than 7 days, then the battery **MUST** be disconnected.

4.2.3 Functional test

The default setting is a 5 seconds test on a weekly basis.

4.2.4 Duration test

The default setting is a duration test conducted every 52 weeks.

For luminaires with Emergency Indicator the following procedure and displays apply.

LED Indication	Status	Comment
Permanent green	System OK	AC mode
Fast flashing green (0.1 sec on – 0.1 sec off)	Function test underway	
Slow flashing green (1 sec on – 1 sec off)	Duration test underway	
Red LED on	Load failure	Open circuit/Short circuit/LED failure
Slow flashing red (1 sec on – 1 sec off)	Battery failure	Battery failed the duration test or function test/Battery is defective or deep discharged/incorrect battery voltage
Fast flashing red (0.1sec on – 0.1 sec off)	Charging failure	Incorrect charging current

Double pulsing green	Inhibit mode	Switching into inhibit mode via controller
Binary transmission of address via green/red LED	Address identification	During address identification mode
Green and red off	DC mode	Battery operation (emergency mode)

4.3 Electrical Fault Finding and Replacement (Refer EN / IEC 60079-19)

The supply must be isolated before opening the luminaire.

Any live fault finding must be done by a competent electrician and, if carried out with luminaire in place, under a permit to work. When electronic high frequency gear is fitted do not megger.

If LED's go out repeatedly, and replacement LED's do not work or expected life is reduced, the control gear should be returned for replacement / testing. The electronic drivers are approved components.

On re-assembly, all faulty/damaged wiring should be replaced, and connections checked.

4.3.1 Battery Check and Replacement (Refer EN / IEC 60079-19)

Do not open luminaire when a hazardous atmosphere is present. Isolate before opening. The battery is detached at the plug and socket. Remove the two screws to release the battery. Re-assembly is in reverse order.

Important: *Although the battery pack is fitted with a polarised plug and socket to prevent accidental shorting, Care must be taken not to short the leads together as this can cause sparking which, in turn, could lead to a fire.*

The emergency duration is 3 hours for the 01L, 02L and the 04L. This is in accordance with IEC 60598 2-22. The battery must be replaced when the duration is not acceptable.

Protect the batteries from water ingress and mechanical damage then transport from the hazardous area as soon as practical. Take care to fully discharge batteries before transporting or otherwise ensure that there can be no release of stored energy in transit.

4.3.2 Checking of Battery separately

If the battery is to be checked separately, it should be charged using a **constant current charger** at 175/350mA for 30/15 hours for the 3.5Ah. Discharge measurement is not easy as the current is proportional to the voltage for resistance loads, so it must be averaged. Discharge the battery at 1 to 2A and multiply current by time. Do not discharge below 1 volt per cell, which is 4V. The capacity should be 75% or more of normal.

5.0 Disposal of Material

Any disposal must satisfy the requirements of the WEEE directive [2012/19/EU and Regulations 2012] and therefore must not be treated as commercial waste. The unit is mainly made from incombustible materials. The control gear contains plastic resin and electronic components. All electrical components may give off noxious fumes if incinerated.

5.1 Battery Disposal

Nickel Hydride batteries are defined as 'controlled waste' under the hazardous waste regulations and the person disposing needs to observe a 'duty of care'.

Batteries can be returned to the manufacturers for recycling. They must be stored and transported safely, and any necessary pollution control forms completed prior to transportation. Take care to fully discharge batteries before transporting, or otherwise ensure that there can be no release of stored energy in transit. For further details refer to our Technical Department.

6.0 Fuse ratings

With the availability of MCB's with a wide range of characteristics, the individual engineer can make a better judgement of what is required. Use MCB's suitable for inrush currents to reduce ratings. Where MCB's are used, the type with the higher short time tripping current ratio used for motor starting and lighting should be specified. The inrush current can be calculated where circuit conditions are known. The inrush currents can be obtained from the manufacturer.

The fuse ratings for LED strips in circuits need to take account of the Driver within the construction of the Luminaire. All calculations must satisfy wiring regulations.

Note: Line currents for 230V, 50Hz are as indicated below in Table A and Table B

Table A - Series Standard Circuit.					
Model	No. Of LED Strips	Nominal Volts	Lumen	Nominal Circuit Power (W)	Line Current (Amp)
01L	1 x 140mm	120-277Vac 50/60 Hz 127-300Vdc	1187	10	0.05
02L	2 x 140mm	120-277Vac 50/60 Hz 127-300Vdc	2245	19	0.09
04L	3 x 140mm	120-277Vac 50/60 Hz 127-300Vdc	3872	31	0.15

Table B - Series Emergency Circuit.					
Model	No. Of LED Strips	Nominal Volts	Lumens Mains/EM	Nominal Circuit Power (W)	Line Current (Amp)
01L NM	1 x 140mm	220-240Vac 50/60 Hz	537	4	0.02
01L	1 x 140mm	220-240Vac 50/60 Hz	1187/537	11	0.05
02L	2 x 140mm	220-240Vac 50/60 Hz	2245/502	20	0.09
04L	3 x 140mm	220-240Vac 50/60 Hz	3872/519	32	0.15



Power Factor 0.9 Minimum



To comply with the Waste Electrical and Electronic Equipment directive 2012/19/EU and Regulations 2012 the apparatus cannot be classified as commercial waste and as such must be disposed of or recycled in such a manner as to reduce the environmental impact.



Chalmit Lighting is a leading supplier of Hazardous Area lighting products

	CHALMIT LIGHTING PO Box 5575 Glasgow, G52 9AP Scotland	
Telephone: +44 (0) 141 882 5555 Fax: +44 (0) 141 883 3704 Email: info@chalmit.com Web: www.chalmit.com	Registered No: 669157 Registered Office: Cannon Place 78 Cannon Street London EC4N 6AF UK	

For technical support, please contact: techsupport@chalmit.com

Note: Chalmit Lighting reserves the right to amend characteristics of our products and all data is for guidance only.



	EU/UK-Declaration of conformity		
	UE-Déclaration de conformité		
	EU-Konformitätserklärung		
Manufacturer	Chalmit	Address	388 Hillington Road, Glasgow. G52 4BL Scotland UK
Product	NexLED 3 Bulkhead Industrial (Standard and Emergency)		
Catalogue	NL3I/**/LE/EM Example: NL3I/01L/LE/EM		
Area Classification	Industrial (Non- Hazardous)		
Ingress Protection	IP66/67		
Ambient	Non-Emergency -40°C to +50°C Emergency -20°C to +50°C		
Terms of the directive:	Standard & Date Certified to	Standards Date Declared to	
Prescription de la directive:	Standard & date certifiée à	Normes date Déclaré	
Bestimmungen der Richtlinie:	Standard & Datum zertifiziert nach	Standards Datum erklärt	
2014/30/EU Regulations 2016	Electromagnetic compatibility	EN 55015 : 2019	
2014/30/UE	Compatibilité électromagnétique	EN 61547 : 2009	
2014/30/EU	Elektromagnetische Verträglichkeit	EN 61000-3-2 : 2019	
2014/35/EU Regulations 2016	Low voltage equipment	EN 60598-1 : 2015	
2014/35/UE	Équipements électriques à bas voltage	EN 60598-2-5 : 2015	
2014/35/EU	Niederspannungsgeräte / -systeme	EN 60598-2-22 : 2014	
		EN 60529 : 1992+A2:2013	
2012/19/EU Regulations 2012	Waste of electrical and electronic equipment		
2012/19/UE	Déchets d'équipements électriques et électroniques		
2012/19/EU	Entsorgung der elektrischen und elektronischen Geräte / Systeme		
2011/65/EU Regulations 2012	RoHS II Directive		

On behalf of the Chalmit, I declare that, on the date the equipment accompanied by this declaration is placed on the market, the equipment conforms to all technical and regulatory requirements of the above listed directives.

En tant que représentant du fabricant Chalmit, je déclare qu'à la date où les équipements accompagnant cette déclaration sont mis sur le marché, ceux-ci sont conformes à toutes les dispositions réglementaires et techniques des directives énumérées ci-dessus.

Hiermit bestätige ich, im Namen von Chalmit, dass am Tag der Lieferung des Produkts/der Produkte zusammen mit dieser Erklärung das Gerät/die Geräte alle technischen und regulativen Anforderungen der oben aufgeführten Direktiven erfüllt.

Name and Date Mark Poutney 09/11/2021
 Nom et Date
 Name und Datum

Technical Manager
 Directeur technique
 Technischer Leiter

Quality Management System Accreditation:
 Système de Management Qualité Accréditation :
 Qualitätsmanagementsystem Akkreditierung:
 Environmental Management System.
 Système de gestion de l'environnement.
 Umwelt kontroll system.
Certificate No./Certificat N°/Zertifikat Nr.

ISO 9001

ISO 14001
 by/par/durch
Lloyd's Register
LRQ 4005876